

**Reproduction of part or all of the contents of this document in any form is expressly prohibited other than for individual use only.
Subject to modifications and errors.
All text, images and labels are property of nimax GmbH and Meade Instruments.**

www.meade.com

MEADE INSTRUCTION MANUAL

LightBridge Mini Telescope Series



LIGHTBRIDGE MINI

(c) nimax GmbH



WARNING!

Never use a Meade® Telescope to look at the Sun! Looking at or near the Sun will cause instant and irreversible damage to your eye. Eye damage is often painless, so there is no warning to the observer that damage has occurred until it is too late. Do not point the telescope at or near the Sun. Children should always have adult supervision while observing.

TABLE OF CONTENTS

Introduction.....	2
Parts of the telescope.....	3-4
About the telescope.....	5
Attaching the red dot viewfinder.....	5
Inserting the eyepiece.....	5
Balancing the telescope.....	6
Aligning the red dot viewfinder.....	7
Using the telescope:	
Understanding celestial movements and coordinates.....	7
The motions of the stars & planets.....	8
The most important rule.....	8
Observing.....	8
Some observing tips.....	13
Specifications.....	15
Calculating the magnification of your eyepiece.....	16
Taking care of your telescope.....	17
Adjusting the azimuth tension.....	18
Optional accessories.....	18
Collimation (alignment) of the optics.....	19
Changing the viewfinder battery.....	22
Recycling information.....	23

INTRODUCTION

Congratulations on getting a Meade LightBridge Mini Telescope! The Meade LightBridge Mini Telescope is an excellent beginner's instrument, and is designed to observe objects in the night sky. It can be your personal window to the universe allowing you to see bright galaxies, planets, stars and more. The telescope is already pre-assembled for you at our factory, so you will only have to attach the accessories to start viewing objects in the night sky.

The telescope is shipped with the following parts:

82mm Mini Dobsonian

- Optical tube
- Dobsonian Mount
- Two Eyepieces
- Barlow lens
- Red dot finder
- Software dvd

114mm Mini Dobsonian

- Optical tube
- Dobsonian Mount
- Two Eyepieces
- Red dot finder
- Software dvd

130mm Mini Dobsonian

- Optical tube
- Dobsonian Mount
- Two Eyepieces
- Red dot finder
- Software dvd

In order to get started observing night sky object, you will need to do the following:

- Attach the red dot viewfinder
- Insert the eyepiece
- Align the red-dot viewfinder
- Balance the telescope
(114mm & 130mm models only)

Study the pictures on the following pages and become acquainted with the parts of your telescope. Figure 1A shows the LightBridge Mini 82mm and Figure 1B shows the LightBridge Mini 114mm & 130mm. When you're comfortable with the telescope part locations, proceed to "ABOUT THE TELESCOPE" on page 5.

FIGURE 1A

Figure 1A: Meade LightBridge 82mm Mini Reflecting Telescope

1. Mount Feet
2. Dobsonian Mount
3. Azimuth Tension Nut
4. Optical Tube Assembly (OTA)
5. Front Dust Cover (not shown)
6. Secondary Mirror Collimation Adjustments (not visible)
7. Red Dot Viewfinder (See inset B)
8. Red Dot Viewfinder Bracket Mounting Thumbscrews (See inset A)
9. Focuser
10. Focuser Drawtube
11. Focuser Knob
12. Eyepiece
13. Eyepiece Holder Thumbscrews
14. Vertical Lock Knob (See inset A)
15. Red Dot Viewfinder Power Switch (See inset B)
16. Red Dot Viewfinder Adjustment Knobs (See inset B)

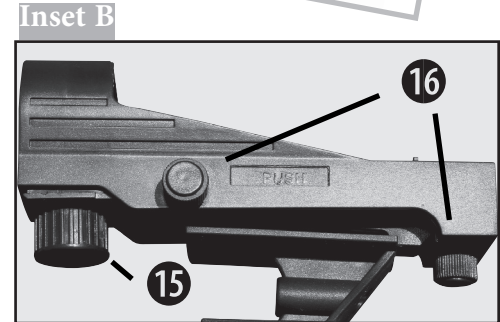
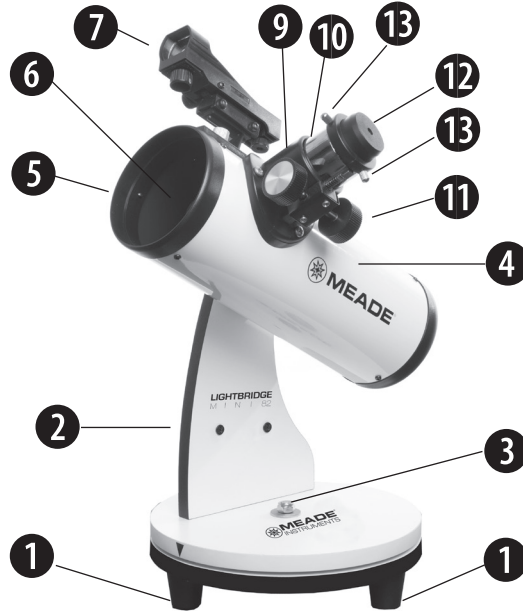
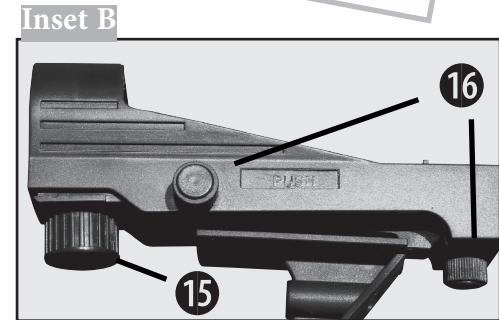
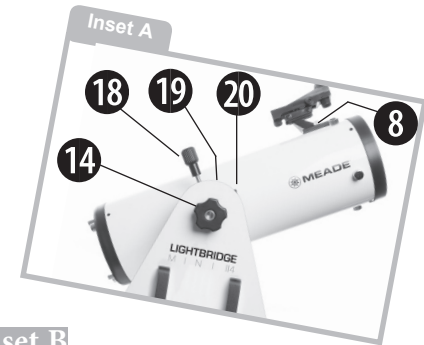
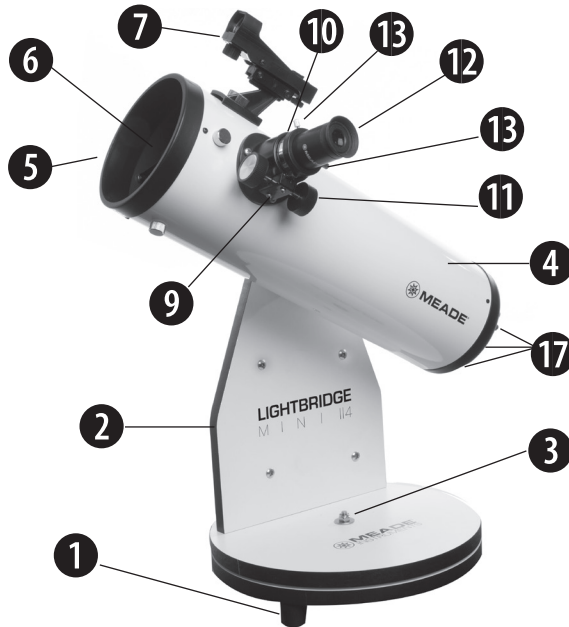

FIGURE 1B

Figure 1B: Meade LightBridge 114mm & 130mm Mini Reflecting Telescope

1. Mount Feet
2. Dobsonian Mount
3. Azimuth Tension Nut
4. Optical Tube Assembly (OTA)
5. Front Dust Cover (not shown)
6. Secondary Mirror Collimation Adjustments (not visible)
7. Red Dot Viewfinder (See inset B)
8. Red Dot Viewfinder Bracket Mounting Thumbscrews (See inset A)
9. Focuser
10. Focuser Drawtube
11. Focuser Knob
12. Eyepiece
13. Eyepiece Holder Thumbscrews
14. Vertical Lock Knob
15. Red Dot Viewfinder Power Switch (See inset B)
16. Red Dot Viewfinder Adjustment Knobs (See inset B)
17. Primary Collimation Adjustment Knobs
18. Dovetail Locking Knob (See inset A)
19. OTA Dovetail (not visible)
20. Dovetail Receiver (not visible)



ABOUT THE TELESCOPE

The telescope mount is the basic support for your telescope. Named after it's inventor John Dobson, this mount style allows for both horizontal and vertical motions. Its height is fixed so using the telescope is best done on a table top or stable elevated surface so that you can view through the eyepiece comfortably. A small table works best so it's easy to move all the way around and you are not limited to where you point and view through the telescope.

The LightBridge Mini Series of telescopes includes several models with optical tubes of different sizes. These optical tubes, called reflectors, use mirrors to bring the incoming light to focus. You'll notice inside the telescope there are two mirrors used to reflect the light and bring it to focus. The primary mirror is the large mirror at the bottom of the tube, and secondary mirror is near the top of the tube. The large primary mirror collects light from the object you're looking at and bounces it forward to the secondary mirror which redirects it out the side of the tube.

The primary mirror diameter of the telescope is one of the most important pieces of information about the telescope. The size of the mirror, also known as "aperture", determines how much detail you will be able to see in your telescope. The LightBridge Mini Telescope Series includes apertures of 82mm, 114mm, and 130mm sized primary mirrors.

The optical tube's focal length information is also important and will help later on to calculate the viewing magnification. The focal length is the distance it takes for the mirrors to focus the light. Each telescope has a different focal length specifically designed to give the best viewing experience.

ATTACHING THE RED DOT VIEWFINDER

An eyepiece (Fig 1, 12) has a narrow field of view. The red dot viewfinder (Fig 1, 7) has a wider field of view, which makes it easier to locate objects. Once the red dot viewfinder is aligned to the optical tube, the red dot can be

used to locate and place objects more easily in the telescopes eyepiece.

1. Note the two thumbscrews (Fig 2, 8) thread onto two bolts on the optical tube. Remove the thumbscrews from the tube.
2. Slide the bracket over the bolts with the

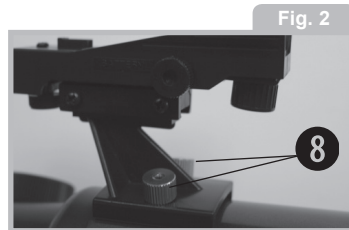

viewfinder lens forward, towards the front of the telescope.

3. Replace the thumbscrews (Fig 1, 8) on to the bolts and tighten to a firm feel.

INSERTING THE EYEPIECE

1. Slide the 26mm eyepiece (Fig 1, 12) directly into the focuser draw tube (Fig 1, 10).

2. Tighten the focuser thumbscrew(s) (Fig 1, 13) to hold the eyepiece securely.

3. When locating objects it is always best to start with the low power (26mm) eyepiece. The 26mm has a wide viewing field that will allow objects to be more easily found. Once located and centered, you can switch to a higher power eyepiece such as a 9mm to increase the viewing power. The higher power will present a larger, dimmer image, with smaller field of view.

BALANCING THE TELESCOPE (114mm & 130mm models only)

Sometimes when using heavy eyepieces or accessories, the optical tube can become out of balance. It is important to balance the optical tube so when you release the vertical lock (Fig 1, 14), the telescope will not swing quickly or move uncontrollably. A balanced telescope also allows for smooth motion when using the telescope. To balance the optical tube, first attach all the desired accessories, then follow these steps:

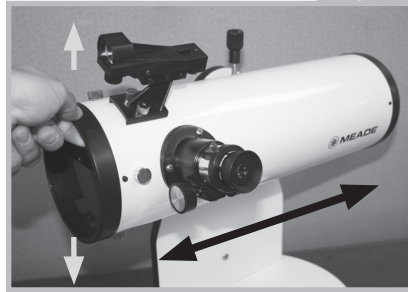

1. Support the optical tube with one hand and loosen the vertical lock knob (Fig 3b, 14) on the side of the mount. The optical tube will turn freely about this axis. If the optical tube tends to move or drift when your supporting hand is moved, it is necessary to balance the optical tube.

2. If the front of the telescope tube wants to rotate downward, the optical tube is too heavy in the front and needs to be adjusted toward the back.

If the back of the telescope wants to rotate

downward, the optical tube is too heavy in the back and should be adjusted forward.

3. Loosen the dovetail locking knob (Fig 3b, 18) slightly and slide the optical tube (Fig 3b, 4) along the dovetail receiver (Fig 3b, 20) until the telescope remains in any given position without tending to drift up or down in the vertical axis (Fig 3a).

NOTE: Do not overloosen the dovetail locking knob or the optical tube could come completely off of the mount.

4. Relock the dovetail locking knob (Fig 3b, 18) until firm. When the telescope is

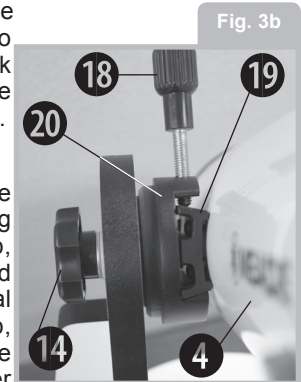

balanced, proceed to “Aligning the red dot viewfinder”.

ALIGNING THE RED DOT VIEWFINDER

The eyepiece has a small field of view. The red-dot viewfinder has a much larger field of view making it an ideal accessory to help point the telescope accurately. The below procedure will walk you through adjusting the red-dot viewfinder so it points at the same location as the telescope.

Performing the first part of this procedure during the daytime may be the easiest.



Fig. 4

1. Point the telescope at an easy-to-find land object such as the top of a telephone pole or a distant mountain or tower.

NOTE: NEVER LOOK AT THE SUN!

Look through the 26mm eyepiece and turn the focuser knob (Fig 1, 11) until the image is sharply focused. Center the object precisely in the eyepiece's field of view.

2. Turn on the red dot viewfinder by turning the on/off switch (Fig 1, 15) clockwise.

3. Look through the red dot viewfinder. Turn one or both of the viewfinder's alignment screws (Fig 1, 16) until the red dot is precisely over the same object as you centered in the eyepiece.

The side alignment screw controls the horizontal, while the rear alignment controls the vertical.

4. Check this alignment at night on a celestial object, such as the Moon or a bright star, and

use the viewfinder's alignment screws to make any necessary refinements.

5. When finished, turn off the red dot viewfinder by rotating the on/off switch (Fig 1, 15) counter-clockwise.

Once they are aligned and pointing at the same location, use the red-dot viewfinder to locate objects by placing the red dot over the object. Then use the 26mm eyepiece to view the object.

If the red-dot viewfinder is properly aligned with the telescope, the object should be somewhere in the 26mm eyepiece.

USING THE TELESCOPE:

UNDERSTANDING CELESTIAL MOVEMENTS AND COORDINATES

Understanding where to locate celestial objects and how those objects move across the sky is the key to enjoying the hobby of astronomy. Most amateur astronomers

practice “star-hopping” to locate celestial objects. They use star charts, astronomical software, or cellphone apps to identify bright stars and star patterns as “landmarks” in their search for astronomical objects.

THE MOTIONS OF THE STARS & PLANETS

Objects in the sky appear to revolve around the celestial pole. (Actually, celestial objects are essentially “fixed” and their apparent motion is caused by Earth’s rotation). During any 24 hour period, stars make one complete revolution about the pole, from East to West, circling with the pole at the center.

THE MOST IMPORTANT RULE

We have one very important rule that you should always follow when using your telescope: Have Fun!

Have a good time when you’re observing. You may not know everything that there is to know about a telescope or what all the sights in the universe are, but that’s OK. Just point



and observe at first.

You will enjoy your telescope even more as you learn more about it. But don't be scared off by difficult terms or complicated procedures. Don't panic! Just relax and enjoy your scope.

You will begin to grow and learn more about astronomy the more you observe. Go on the internet or to the library and read some books about the stars and planets. Read about astronomers of old. Many of them had telescope no bigger than the one you

are using right now. Galileo, who is one of the first astronomers to use a telescope, discovered four of the moons of Jupiter with a telescope about the same size as yours (and his didn't even focus very well!).

OBSERVING

Observe during the daytime: Try out your telescope during the daytime at first. It is easier to learn how it operates and how to observe when it is light. **NOTE:** If using the LightBridge Mini Series telescope in the daytime, you'll notice the image may be upside down or reversed. due to the position of the eyepiece. This is normal for reflecting (mirrored) telescopes. Reflecting telescopes are meant for night time where image orientation is not important. There is no “this side up” in space.

THE MEADE 4M COMMUNITY

You haven't just bought a telescope, you have embarked on an astronomy adventure that never ends. Share the journey with others by accepting your free membership in the 4M community of astronomers.

Go to www.Meade4M.com to activate your membership today.

Pick out an easy object to observe: A distant mountain, a large tree, a lighthouse or skyscraper make excellent targets. Point the optical tube so it lines up with your objects. Try using the red-dot viewfinder to locate objects too.

Unlock the lock knobs: To move the telescope, you will need to unlock the Vertical lock knob (Fig 1, 14) (just rotate to unlock or lock; when locking, only tighten to a “firm feel,” do not over tighten).

Use the red dot viewfinder: If you have not done so, align the viewfinder (Fig 1, 7) with the telescope’s eyepiece (Fig 1, 12) as described earlier. Look through the red dot viewfinder until you can see the object. It will be easier to locate an object using the red dot viewfinder rather than locating with the eyepiece. Line up the object using the viewfinders red dot.

Look through the eyepiece: Once you have the object lined up in the viewfinder,

look through the optical tube’s eyepiece. If you have aligned your viewfinder, you will see the object in your eyepiece.

Focus: Look through the eyepiece and practice focusing on the object you have chosen.

Observe the Moon: When you feel comfortable with the viewfinder, the eyepieces, the locks and the adjustment controls, you will be ready to try out the telescope at night. The Moon is the best object to observe the first time you go out at night. Pick a night

TOO MUCH POWER?

Can you ever have too much power? If the type of power you’re referring to is eyepiece magnification, yes you can! The most common mistake of the beginning observer is to “overpower” a telescope by using high magnifications which the telescope’s aperture and atmospheric conditions cannot reasonably support. Keep in mind that a smaller, but bright and well-resolved image is far superior to one that is larger, but dim and poorly resolved. Powers above 400x should be employed only under the steadiest atmospheric conditions.

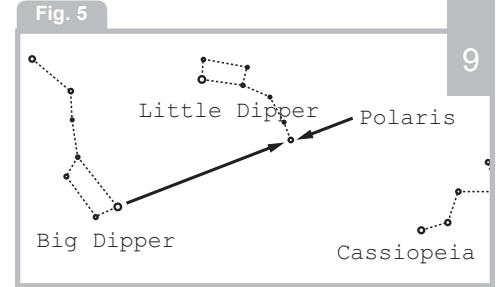

when the Moon is a crescent. No shadows are seen during a full Moon, making it appear flat and uninteresting.

Look for different features on the Moon. The most obvious features are craters. In fact you can see craters within craters. Some craters have bright lines about them. These are called rays and are the result of material thrown out of the crater when it was struck by a colliding object. The dark areas on the Moon are called maria and are composed of lava from the period when the Moon still had volcanic activity. You can also see mountain ranges and fault lines on the Moon.

Use a neutral density filter (often called a “moon filter”) when observing the Moon. Neutral density filters are available from Meade as an optional accessory and enhance contrast to improve your observation of lunar features.

Spend several nights observing the Moon. Some nights, the Moon is so bright that it makes other objects in the sky difficult to see. These are nights that are excellent for lunar observation.

Observe the Solar System: After observing the Moon, you are ready to step up to the next level of observation, the planets.

There are four planets that you can easily observe in your telescope: Venus, Mars, Jupiter and Saturn.

Nine planets (maybe more!) travel in a fairly circular pattern around our Sun. Any system of planets orbiting one or more stars is called a solar system. Our Sun, by the way, is a

single, yellow dwarf star. It is average as far as stars go and is a middle aged star.

Beyond the planets are clouds of comets, icy planetoids and other debris left over from the birth of our sun. Recently astronomers have found large objects in this area and they may increase the number of planets in our solar system.

The four planets closest to the Sun are rocky and are called the inner planets. Mercury, Venus, Earth and Mars comprise the inner planets. Venus and Mars can be easily seen in your telescope.

Venus is seen before dawn or after sunset, because it is close to the Sun. You can observe Venus going through crescent phases. But you cannot see any surface detail on Venus because it has a very thick atmosphere of gas.

When Mars is close to the Earth, you can see some details on Mars, and sometimes even Mars’ polar caps. But quite often, Mars is

further away and just appears as a bright red star or very small disk and may show some dark lines crisscrossing it.

Jupiter, Saturn, Uranus, Neptune and Pluto comprise the outer planets. These planets, except for Pluto, are made mostly of gases and are sometimes called gas giants. If they had grown much bigger, they may have become stars. Pluto is made mostly of ice.

Jupiter is quite interesting to observe. You can see bands across the face of Jupiter. The more time you spend observing these bands,

Meade Factoid

Jupiter’s four brightest moons are easily visible in a telescope. When Galileo Galilei first observed them rotating around Jupiter in 1610, he saw proof that the earth wasn’t the center of everything in the universe, as many then supposed.

the more details you will be able to see.

One of the most fascinating sights of Jupiter are its moons. The four largest moons are called the Galilean moons, after the astronomer Galileo, who observed them for the first time. If you've never watched the Galilean moons in your telescope before, you're missing a real treat! Each night, the moons appear in different positions around the Jovian sky. This is sometimes called the Galilean dance. On any given night, you might be able to see the shadow of a moon on the face of Jupiter, see one moon eclipse another or even see a moon emerge from behind Jupiter's giant disk. Drawing

Fig. 6



the positions of the moons each night is an excellent exercise for novice astronomers.

Any small telescope can see the four Galilean moons of Jupiter (Fig. 6), plus a few others, but how many moons does Jupiter actually have? No one knows for sure! Nor are we sure how many Saturn has either. At last count, Jupiter had over 60 moons, and held a small lead over Saturn. Most of these moons are very small and can only be seen with very large telescopes.

Probably the most memorable sight you will see in your telescope is Saturn. Although you may not see many features on the surface of Saturn, its ring structure will steal your breath away. On nights of very steady seeing you may be able to see a black opening in the rings, known as the Cassini band.

Saturn is not the only planet that has rings, but it is the only set of rings that can be seen with a small telescope. Jupiter's rings cannot be seen from Earth at all—the Voyager spacecraft discovered the ring after it passed Jupiter and looked back at it. It turns out, only with the sunlight shining through them, can the rings be seen. Uranus and Neptune also have faint rings.

Optional color filters help bring out detail and contrast of the planets. Meade offers a line of inexpensive color filters.

What's Next? Beyond the Solar System: Once you have observed our own system

Meade Factoid

Saturn's rings of ice, dust and gas are huge and small at the same time. The main rings are so large they could almost reach from the earth to the moon. But they are only about a half of a mile (just a few city blocks) wide.

of planets, it's time to really travel far from home and look at stars and other objects.

You can observe thousands of stars with your telescope. At first, you may think stars are just pinpoints of light and aren't very interesting. But look again. There is much information that is revealed in stars.

The first thing you will notice is that not all stars are the same colors. See if you can find blue, orange, yellow, white and red stars. The color of stars sometimes can tell you about the age of a star and the temperature that they burn at.

Other stars to look for are multiple stars. Very often, you can find double (or binary) stars, stars that are very close together. These stars orbit each other. What do you notice about these stars? Are they different colors? Does one seem brighter than the other?

Almost all the stars you can see in the sky are part of our galaxy. A galaxy is a

large grouping of stars, containing millions or even billions of stars. Some galaxies form a spiral (like our galaxy, the Milky Way) and other galaxies look more like a large football and are called elliptical galaxies. There are many galaxies that are irregularly shaped and are thought to have been pulled apart because they passed too close to—or even through—a larger galaxy.

You may be able to see the Andromeda galaxy and several others in your telescope. They will appear as small, fuzzy clouds. Only very large telescope will reveal spiral or elliptical details.

You will also be able to see some nebulas with your scope. Nebula means cloud. Most nebulas are clouds of gas. The two easiest to see in the Northern Hemisphere are the Orion nebula during the winter and the Triffid nebula during the summer. These are large clouds of gas in which new stars are being born. Some nebulas are the remains of stars exploding. These explosions are called supernovas.

When you become an advanced observer you can look for other types of objects such as asteroids, planetary nebula and globular clusters. And if you're lucky, every so often a bright comet appears in the sky, presenting an unforgettable sight.

The more you learn about objects in the sky, the more you will learn to appreciate the sights you see in your telescope. Start a notebook and write down the observations you make each night. Note the time and the date.

SURF THE WEB

- The Meade 4M Community:
<http://www.meade4m.com>
- Sky & Telescope:
<http://www.skyandtelescope.com>
- Astronomy:
<http://www.astronomy.com>
- Astronomy Picture of the Day:
<http://antwrp.gsfc.nasa.gov/apod>
- Photographic Atlas of the Moon:
http://www.lpi.ursa.edu/research/lunar_orbiter
- Hubble Space Telescope Public Pictures:
<http://oposite.stsci.edu/pubinfo/pictures.html>

Use a compass to make a circle, or trace around the lid of a jar. Draw what you see in your eyepiece inside the circle. Or, use the observing logs located in the back of this manual. The best exercise for drawing is to observe the moons of Jupiter every night or so. Try to make Jupiter and the moons approximately the same size as they look in your eyepiece. You will see that the moons are in a different position every night. As you get better at drawing, try more challenging sights, like a crater system on the moon or even a nebula.

Go your library or check out the internet for more information about astronomy. Learn about the basics: light years, orbits, star colors, how stars and planets are formed, red shift, the big bang, what the different kinds of nebula are, what are comets, asteroids and meteors and what a black hole is. The more you learn about astronomy, the more fun, and the more rewarding your telescope will become.

SOME OBSERVING TIPS

Eyepieces: Always begin your observations using the 26mm low-power eyepiece. The 26mm eyepiece delivers a bright, wide field of view and is the best to use for most viewing conditions. Use the high-power 9mm eyepiece to view details when observing the Moon and planets. If the image become fuzzy, switch back down to a lower power. Changing eyepieces changes the power or magnification of your telescope.

By the way, users of reflecting (mirrored) telescopes may have noticed something strange when looking through your eyepiece. The image is upside down and reversed. That means reading words can be a problem. But it has no effect on astronomical objects.

Optional Accessory Barlow lens: You can also change magnification by using a Barlow lens. The Barlow lens doubles the power of your telescope (See Fig. 7).

Meade offers a complete line of eyepieces for your telescope. Most astronomers have four or five low-power and high power eyepieces to view different objects and to cope with different viewing conditions.

Objects move in the eyepiece: If you are observing an astronomical object (the Moon, a planet, star, etc.) you will notice that the object will begin to move slowly through the telescopic field of view. This movement is caused by the rotation of the Earth and makes an object move through the telescope's field of view. To keep astronomical objects centered in the field, simply move the telescope on

STAR CHARTS

Star charts and planispheres are useful for a variety of reasons. In particular, they are a great aid in planning a night of celestial viewing.

A wide variety of star charts are available in books, in magazines, on the internet and on CD Roms. Meade offers AutoStar Suite™ software. Contact your local Meade dealer or Meade's Customer Service department for more information.

Astronomy and Sky and Telescope magazines print star charts each month for up-to-the-minute maps of the heavens.

one or both of its axes—vertically and/or horizontally as needed. At higher powers, astronomical objects will seem to move through the field of view of the eyepiece more rapidly.

Place the object to be viewed at the edge of the field and, without touching the telescope, watch it drift through the field to the other side before repositioning the telescope so that the object to be viewed is again placed at the edge of the field, ready to be further observed.

Vibrations: Avoid touching the eyepiece while observing through the telescope. Vibrations resulting from such contact will cause the image to move. Avoid observing sites where vibrations cause image movement (for example, near railroad tracks). Viewing from the upper floors of a building may also cause image movement.

Let your eyes “dark-adapt”: Allow five or ten minutes for your eyes to become “dark adapted” before observing. Use a red-filtered flashlight to protect your night vision

when reading star maps, or inspecting the telescope. Stay away from bright lights too. Do not use a regular flash-light or turn on other lights when observing with a group of other astronomers. You can make your own red filtered flashlight by taping red cellophane over a flashlight lens.

Viewing through windows: Avoid setting up the telescope inside a room and observing through an opened or closed window pane. Images may appear blurred or distorted due to temperature differences between inside and outside air. Also, it is a good idea to allow your telescope to reach the ambient

(surrounding) outside temperature before starting an observing session.

When to observe: Planets and other objects viewed low on the horizon often lack sharpness—the same object, when observed higher in the sky, will appear sharper and have greater contrast. Try reducing power (change your eyepiece) if your image is fuzzy or shimmers. Keep in mind that a bright, clear, but smaller image is more interesting than a larger, dimmer, fuzzy one. Using too high a power eyepiece is one of the most common mistakes made by new astronomers.

Dress Warm: Even on summer nights, the air can feel cool or cold as the night wears on. It is important to dress warm or to have a sweater, jacket, gloves, etc., nearby.

Know your observing site: If possible, know the location where you will be observing. Pay attention to holes in the ground and other obstacles. Is it a location where wild animals, such as skunks, snakes, etc., may appear? Are there viewing obstructions such as tall trees, street lights, headlights and so forth?



The best locations are dark locations, the darker the better. Deep space objects are easiest to see under dark skies. But it is still possible to observe even in a city.

Surf the Web and visit your local library: The internet contains a huge amount of astronomical information, both for children and adults. Check out astronomy books from your library. Look for star charts—these are available on a monthly basis in *Astronomy and Sky* and *Telescope* magazines.

**HAVE A GOOD TIME,
ASTRONOMY IS FUN!**

JOIN AN ASTRONOMY CLUB, ATTEND A STAR PARTY

One of the best ways to increase your knowledge of astronomy is to join an astronomy club. Check your local newspaper, school, library, or telescope dealer/store to find out if there's a club in your area.

Many groups also hold regularly scheduled Star Parties at which you can check out and observe with many different telescopes and other pieces of astronomical equipment. Magazines such as *Sky and Telescope* and *Astronomy* print schedules for many popular Star Parties around the United States and Canada.

SPECIFICATIONS

LightBridge 82mm

- Optical tube design.....Reflector
- Optical tube focal length.....300mm
- Primary mirror diameter.....82mm (3.2 in.)
- Focal ratio.....f/3.7
- Viewfinder.....Red dot
- Eyepieces.....Two(2) 1.25" H26mm, H9mm
- 2X Barlow.....Included

LightBridge 114mm

- Optical tube design.....Reflector
- Optical tube focal length.....450mm
- Primary mirror diameter.....114mm (4.5 in.)
- Focal ratio.....f/4
- Viewfinder.....Red dot
- Eyepieces.....Two(2) 1.25" MA26mm
MA9mm
- 2X Barlow.....Optional Accessory

LightBridge 130mm

- Optical tube design.....Reflector
- Optical tube focal length.....650mm
- Primary mirror diameter.....130mm (5.1 in.)
- Focal ratio.....f/5
- Viewfinder.....Red dot
- Eyepieces.....Two(2) 1.25" MA26mm
MA9mm
- 2X Barlow.....Optional Accessory

Optical tube focal length is simply a measurement of the length of the optical tube. In other words, this is the distance light travels in the telescope before being brought to focus in you eyepiece. For example, the LightBridge Mini 130 focal length is 650mm long.

Primary mirror diameter (reflectors) or Objective lens diameter (refractors) is how big the mirror or lens is on your scope. Telescopes are always described by how large their primary mirror/lens is. For example, the objective lens on the LightBridge Mini 130 is 130mm or 5.1 inches. Telescopes come in many different sizes. They can be 70mm, 8 inches, 16 inches, or even 3 feet in diameter. The Hubble Space Telescope's primary mirror has a diameter of 2.4 meters (that's 7.8 feet across!).

The focal ratio helps determine how fast the photographic speed of a telescope is. The lower the focal ratio number, the faster the exposure. F/5 is faster than f/10. The slower the focal ratio, the longer the exposure time

is needed when a camera is hooked up to the telescope. For example, the Lighbridge Mini 130mm Reflector has fast focal ratio at f/5.

CALCULATING THE MAGNIFICATION OF YOUR EYEPIECE

The power of a telescope is how much it magnifies objects. Each telescope has its own set of focal lengths and, therefore, different magnifications when used with various eyepieces. For example, the Lighbridge Mini 130mm used with the 26mm eyepiece magnifies an object 25 times. The

9mm eyepiece used with the Lighbridge Mini 130mm will magnify objects 72 times.

You can calculate how much magnification an eyepiece will have with your specific telescope. Just divide the telescope focal length by the focal length of the eyepiece.

$$\begin{array}{r} \text{Focal Length of the Telescope} \\ \div \\ \text{Focal Length of the Eyepiece} \\ = \\ \text{Magnification} \end{array}$$

ASTRONOMY RESOURCES

- The Meade 4M Community
27 Hubble, Irvine, CA 92618
- Astronomical League
Executive Secretary
5675 Real del Norte, Las Cruces, NM 88012
- The Astronomical Society of the Pacific
390 Ashton Ave., San Francisco, CA 94112
- The Planetary Society
65 North Catalina Ave, Pasadena, CA 91106
- International Dark-Sky Association, Inc.
3225 N. First Avenue, Tucson, AZ 85719-2103

Fig. 7



Look at the specifications. For example, you will see that the focal length of the Lighbridge Mini 130mm is 650mm. Let's say that you have obtained a 6.3mm eyepiece. You can tell what the focal length of your eyepiece is as it is always printed on the side of the eyepiece. Divide: $650\text{mm} \div 6.3\text{mm}$, which equals 103.17. Round this off to the nearest whole number and you find the 6.3mm eyepiece used with the Lighbridge Mini 130mm magnifies objects 103 times.

If you use a Barlow lens with one of your eyepieces, it doubles the magnification of your eyepiece. Other types of Barlows can triple or further increase the power of an eyepiece. To find out how much your magnification is when you use a 2x Barlow, multiply your eyepiece's magnification by two.

For example, the 9mm low-power eyepiece used with the Lighbridge Mini 130mm magnifies an object 72 times. Multiply 72 by 2 and you get 144 times magnification with a Barlow.

Eyepiece's magnification x 2

=

Magnification with a 2X Barlow lens

It's worth repeating: Keep in mind that a bright, clear, but smaller image is more interesting than a larger, dimmer, fuzzy one. Using too high a power eyepiece is one of the most common mistakes made by new astronomers. So don't think that higher magnification is necessarily better—quite often the best view is with lower magnification value!

TAKING CARE OF YOUR TELESCOPE

Your telescope is a precision optical instrument designed for a lifetime of rewarding viewing. It will rarely, if ever, require factory servicing or maintenance. Follow these guidelines to keep your telescope in the best condition:

- As with any quality instrument, lens or mirror surfaces should be cleaned as infrequently as possible. Telescope optics should be cleaned

only when absolutely necessary. In all cases avoid touching any mirror surface. A little dust on the surface of a mirror or lens causes negligible loss of performance and should not be considered reason to clean the surface. When lens or mirror cleaning does become necessary, use a camel's hair brush or compressed air gently to remove dust. If the telescope's dust cover is replaced after each observing session, cleaning of the optics will rarely be required.

- Fingerprints and organic materials on the lens or mirror may be removed with a solution of 3 parts distilled water to 1 part isopropyl alcohol. You may also add 1 drop of biodegradable dishwashing soap per pint of solution. Use soft, white facial tissues and make short, gentle strokes. Change tissues often.

CAUTION: Do not use scented or lotioned tissues or damage could result to the optics. **DO NOT** use a commercial photographic lens cleaner.

ADJUSTING THE AZIMUTH TENSION

The LightBridge Series Telescopes can move in both the horizontal and vertical motions. The tightness of the vertical motion is controlled by adjusting the vertical lock knob (Fig 1, 14).

The tension for the horizontal motion is adjusted at the Meade factory. If the adjustment is not to your liking, it is easy to adjust by tightening/loosening one screw (Fig 1, 14).

Two wrenches are needed to make the adjustment. One wrench is needed to hold the screw head located at the bottom side of the mount base. The other wrench is placed on the Azimuth Tension Nut (Fig 1, 3) and adjusted as desired.

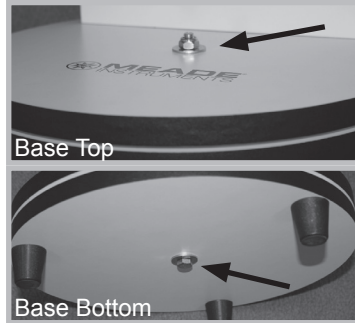

OPTIONAL ACCESSORIES

For an up to date list of compatible Meade accessories, contact your Meade Dealer or see the Meade online catalog for more information. Visit us on the web at www.meade.com.

Additional Eyepieces (1.25" barrel diameter only): For higher or lower viewing magnifications, Meade's eyepieces are available in a wide variety of focal lengths and provide a high level of image resolution and color correction at economical prices.

Available as individual eyepieces or in sets with carry case!

Color/Moon(Neutral Density) Filters: Meade Color filters permit observation of planetary/lunar surface detail that is often virtually invisible without filtration. Choose the filter or filter set that best meet your needs and see what you have been missing!

Barlow Lens: The Meade 2x or 3x Barlow doubles or triples the magnification of your 1.25" eyepieces. The 2x is our most popular Barlow due to its excellent quality, value, and usefulness on nearly every model telescope sold.

Laser Collimator: Easily and quickly align your telescope optics! May be used on any standard Newtonian reflector telescope where the optical system contains two independently adjustable mirrors. Features adjustable brightness. Powered from a single CR2032 type battery (included).

COLLIMATION (ALIGNMENT) OF THE OPTICS

All Meade LightBridge Mini Reflecting telescopes are optically aligned at the factory prior to shipment. It is unlikely that you will need to align, or collimate, the optics after receipt of the instrument. However, if the telescope received unusually rough handling in shipment, it is possible that the optics must be re aligned for best optical performance. In any case this alignment procedure is simple, and requires only a few minutes time. Take the time to familiarize yourself with the following collimation procedure, so that you will recognize a properly collimated instrument and can adjust the collimation if necessary.

A. CORRECT COLLIMATION

The properly collimated (aligned) mirror system in the Meade LightBridge Mini telescope assures the sharpest images possible. This occurs when the primary mirror and secondary mirror are tilted so that the focused image falls directly through the center of the focuser draw tube. These mirror

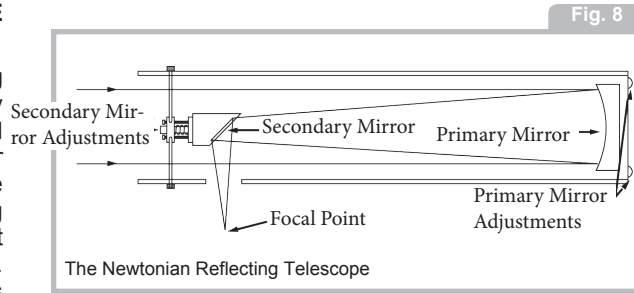

tilt adjustments are made with the secondary mirror assembly and the primary mirror cell (Fig. 10) and will be discussed later.

To inspect the view of the mirror collimation, look down the focuser draw tube with the eyepiece removed. The edge of the focuser drawtube (Fig. 11, 1), will frame the reflections of the primary mirror with the 3 mirror clips (Fig. 11, 2), the secondary mirror (Fig. 11, 3), the spider vanes (Fig. 11, 4), and your eye (Fig. 11, 5). Properly aligned, all of these reflections will appear concentric (i.e., centered) as illustrated in Fig. 11.

Fig. 8

Any deviation from the concentric reflections will require adjustments to the secondary mirror assembly (Fig. 9) and/or the primary mirror cell (Fig. 10).

B. SECONDARY MIRROR HOLDER ADJUSTMENTS

If the secondary mirror (Fig. 12, 1) is centered in the draw tube (Fig. 12, 2), but the primary mirror is only partially visible in the reflection (Fig. 12, 3), one or more of the 3 secondary mirror collimation screws need adjusting. First, unthread each of the secondary mirror collimation screws slightly to the point of where you can tilt the secondary holder from side-to-side. By grasping the secondary holder with your hand, tilt the secondary mirror holder until you see the primary mirror become as centered in the reflection of the diagonal mirror as possible. Once you are at the best position, thread in the 3 secondary mirror collimation screws to lock the holder in place. Then, if necessary, make adjustments to these 3 screws to refine the tilt-angle of the secondary mirror until the entire primary mirror can be seen centered

within the secondary mirror reflection. When the secondary mirror is correctly aligned, it will look like Fig. 13 (Note: The primary mirror is shown out of alignment).

C. PRIMARY MIRROR ADJUSTMENTS (114mm & 130mm models only)

If the secondary mirror (Fig. 13, 1) and the reflection of the primary mirror (Fig. 13, 2) appear centered within the draw tube (Fig. 13, 3), but the reflection of your eye and the reflection of the secondary mirror (Fig. 13, 4) appear off center, you will need to adjust the primary mirror tilt screws of the primary mirror cell (Fig. 10, 2). These primary tilt screws are located behind the primary mirror, at the lower end of the main tube.

NOTE: The LightBridge 82mm telescope does not have primary mirror collimation screws and is permanently mounted at the factory.

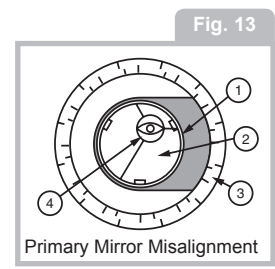
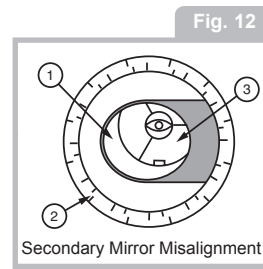
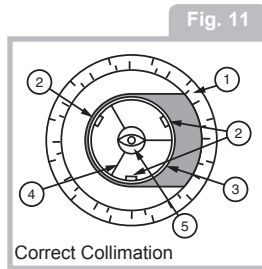
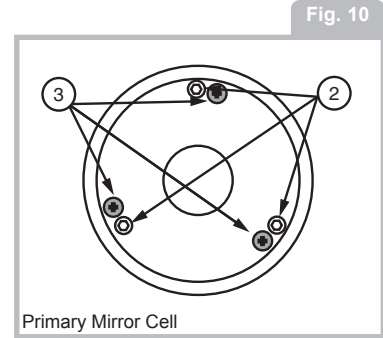
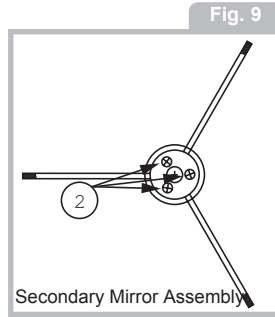

To adjust the primary mirror tilt screws (Fig. 10, 2), first turn by several turns, the primary mirror cell lock knobs (Fig. 10, 3) that are next to each primary mirror tilt screw. The three primary mirror cell locking screws are slotted head screws on the Lighbridge 114/130 Mini models.

Then by trial-and-error, turn the primary mirror tilt knobs (Fig. 10, 2) until you develop a feel for which way to turn each knob to center the reflection of your eye. Once centered, as in Fig. 11, turn the 3 primary mirror cell locking screws (Fig. 10, 3) to re-lock the tilt-angle adjustment.

D. STAR TESTING THE COLLIMATION

With the collimation performed, you will want to test the accuracy of the alignment on a star. Use the 26mm eyepiece and point the telescope at a moderately bright (second or third magnitude) star, then center the star image in the telescope's field-of-view. With the star centered follow the method below:

- Bring the star image slowly out of focus until one or more rings are visible around the central disc. If the collimation was performed correctly, the central star disk and rings will be concentric circles, with a dark spot dead center within the out-of-focus star disk (this is the shadow of the secondary mirror), as shown in Fig. 14C. (An improperly aligned telescope will reveal elongated circles (Fig. 14A), with an off-center dark shadow.)
- If the out-of-focus star disk appears elongated (Fig. 14A), you will need to adjust the primary mirror adjusting tilt screws of the primary mirror cell (Fig. 10, 3)

- To adjust the primary mirror tilt screws (Fig. 10, 3), first unscrew several turns the 3 slotted-head primary mirror cell locking screws (Fig. 10, 2), to allow free turning movement of the tilt knobs.
- Move the telescope until the star image is at the edge of the field-of-view in the eyepiece, as in Fig. 14B.

- As you make adjustments to the primary mirror tilt screws (Fig. 10, 3), you will notice that the out-of-focus star disk image will move across the eyepiece field. Choose one of the 3 primary mirror tilt screws and slightly move the shadow to the center of the disk. Then slightly move the telescope to center the star disk image in the center of the eyepiece.
- If any further adjustments are necessary, repeat this process as many times as needed until the out-of-focus star disk appears as in Fig. 18C, when the star disk image is in the center of the eyepiece field.

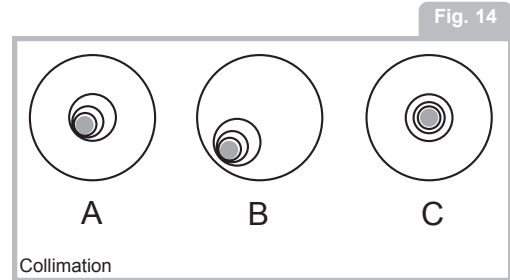

- With the star testing of the collimation complete, tighten the 3 slotted-head primary mirror locking screws (Fig. 10, 2)

Meade also sells a Laser Collimator accessory that will simplify collimation of the optics. This device works by shining a red laser onto the optics and viewing the reflected light. If the reflected light beam is not centered on the device, it can be easily adjusted using the telescope adjustments until the beam is centered.

CHANGING THE VIEWFINDER BATTERY

If the viewfinder red dot does not illuminate, verify the viewfinder is on by rotating the power switch (Fig 1, 15) below the viewfinder lens clockwise. If the red dot does not illuminate, the battery may need replacing.

To replace the battery, press the left side of the viewfinder housing labeled “push”. The battery compartment will slide out on the right side of the viewfinder (see Fig. 15). Replace the battery with a Lithium CR2032 battery with the positive side up. Then push the battery compartment back into the viewfinder and power on.

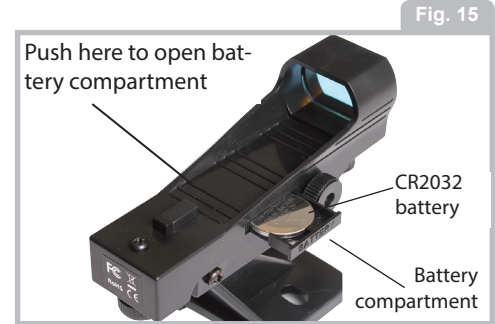

RECYCLING INFORMATION (EU Countries only)

Correct Disposal of this Product (Waste Electrical & Electronic Equipment)

This marking shown on the product or its literature indicates that it must not be disposed of in unsorted municipal waste at the end of its working life. To prevent possible harm to the environment or human health from uncontrolled waste disposal, please separate this from other types of wastes and recycle it as required by law. Household users should contact either the retailer where they purchased this product, or their local government office, for details of where and how they can take this item for environmentally safe recycling. Business users should contact their supplier and check the terms and conditions of the purchase contract. This product should not be mixed with other commercial wastes for disposal.



OBSERVATION LOG

OBSERVER: _____

OBJECT NAME: _____

DATE & TIME OBSERVED: _____

CONSTELLATION: _____

EYEPIECE SIZE: _____

SEEING CONDITIONS: EXCELLENT GOOD POOR

NOTES: _____



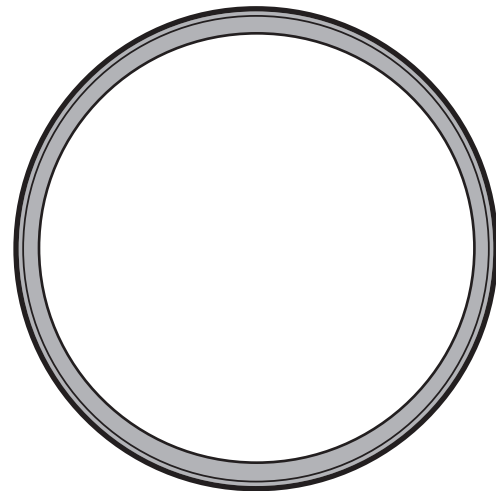

DRAWING OF IMAGE

OBSERVATION LOG

OBSERVER: _____

OBJECT NAME: _____

DATE & TIME OBSERVED: _____

CONSTELLATION: _____

EYEPIECE SIZE: _____

SEEING CONDITIONS: EXCELLENT GOOD POOR

NOTES: _____



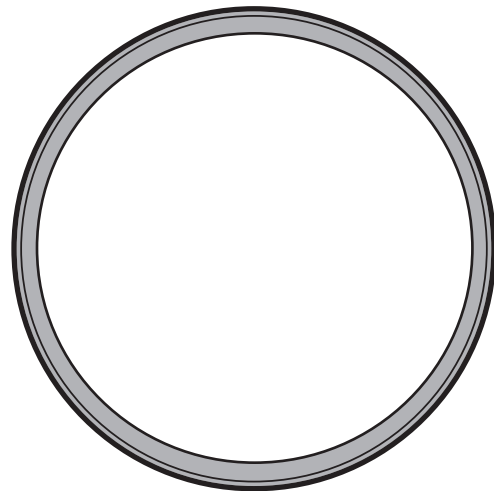

DRAWING OF IMAGE

OBSERVATION LOG

OBSERVER: _____

OBJECT NAME: _____

DATE & TIME OBSERVED: _____

CONSTELLATION: _____

EYEPIECE SIZE: _____

SEEING CONDITIONS: EXCELLENT GOOD POOR

NOTES: _____



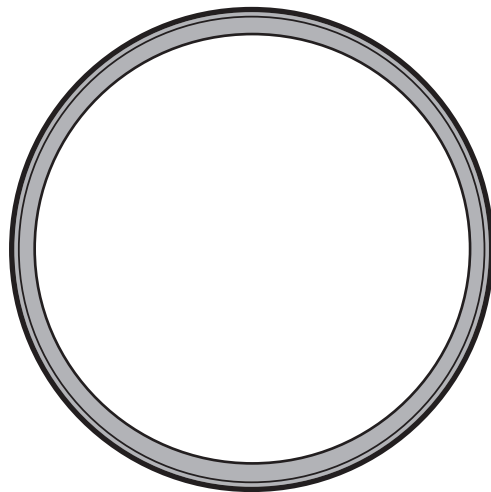
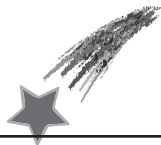

DRAWING OF IMAGE

OBSERVATION LOG

OBSERVER: _____

OBJECT NAME: _____

DATE & TIME OBSERVED: _____

CONSTELLATION: _____

EYEPIECE SIZE: _____

SEEING CONDITIONS: EXCELLENT GOOD POOR

NOTES: _____



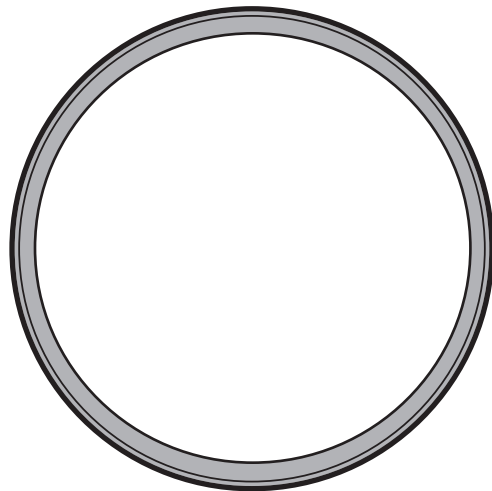

DRAWING OF IMAGE

OBSERVATION LOG

OBSERVER: _____

OBJECT NAME: _____

DATE & TIME OBSERVED: _____

CONSTELLATION: _____

EYEPIECE SIZE: _____

SEEING CONDITIONS: EXCELLENT GOOD POOR

NOTES: _____



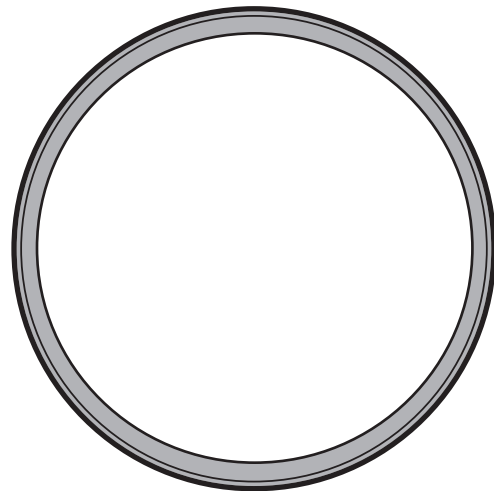

DRAWING OF IMAGE

(c) nimax GmbH

Meade Instruments Corp.
27 Hubble, Irvine,
California

www.meade.com

