

INSTRUCTION MANUAL

Orion[®] SkyView Pro[™] EQ Mount

#9829



 **ORION[®]**
TELESCOPES & BINOCULARS
Providing Exceptional Consumer Optical Products Since 1975

Customer Support (800)-676-1343
E-mail: support@telescope.com
Corporate Offices (831)-763-7000
89 Hangar Way, Watsonville, CA 95076

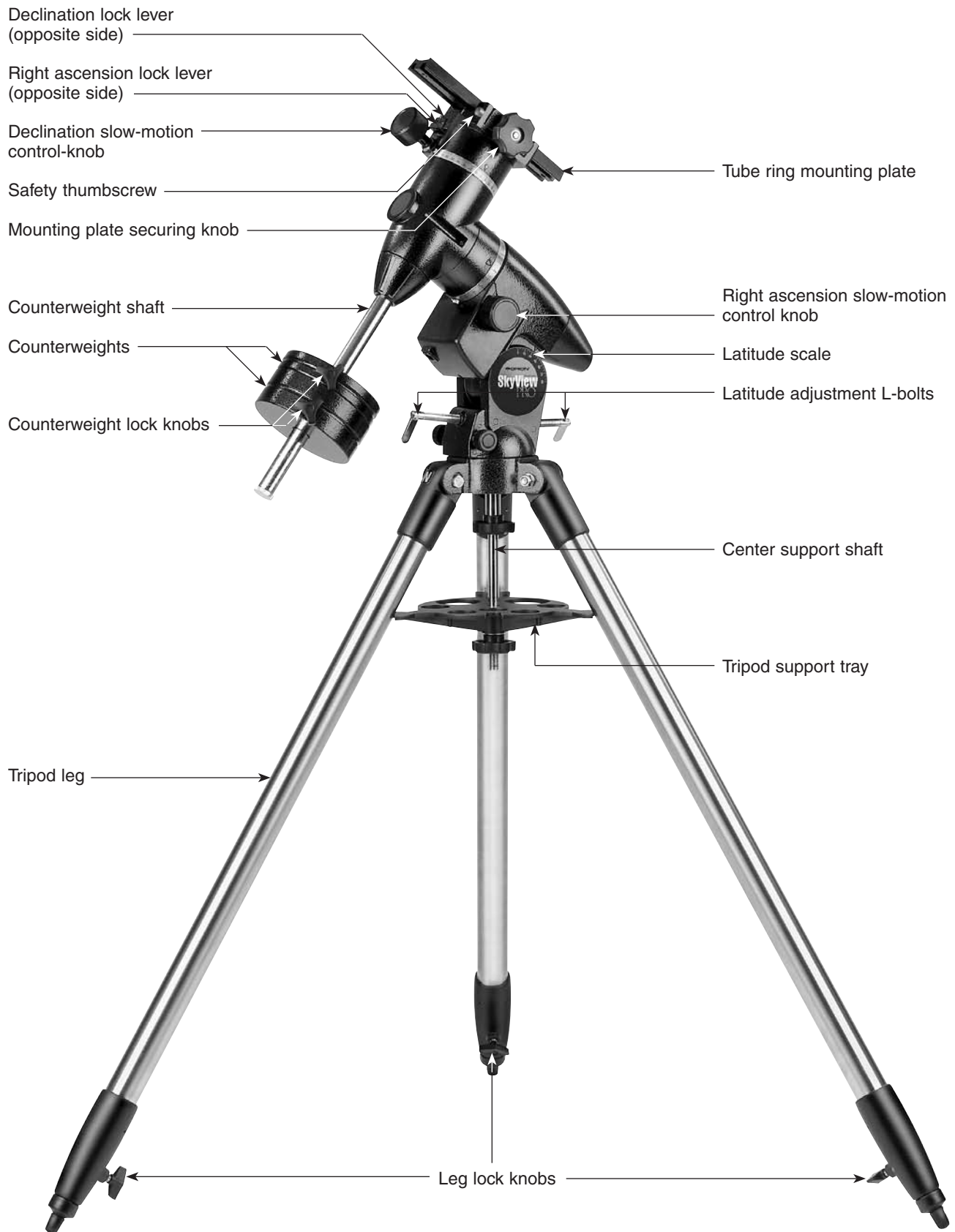

Figure 1. The SkyView Pro EQ Mount.

Congratulations on your purchase of a quality Orion mount. Your new SkyView Pro Equatorial Mount was developed to work with many different telescope optical tubes. Designed for astronomical use, this precision mount allows convenient “tracking” of celestial objects as they move slowly across the sky, so they remain within your eyepiece’s field of view. The setting circles built into the mount will assist you in locating hundreds of fascinating celestial denizens, including galaxies, nebulas, and star clusters, from their catalogued coordinates. With a little practice, you’ll find that the SkyView Pro Equatorial Mount is an invaluable tool for getting the most out of your astronomical observing sessions.

These instructions will help you set up and properly use your equatorial mount. Please read them over thoroughly before getting started.

Table of Contents

1. Unpacking	3
2. Parts List	3
3. Assembly	3
4. Attaching a telescope	4
5. Balancing the telescope	4
6. Setting up and using the equatorial mount	5
7. Specifications	9

1. Unpacking

The entire mount will arrive in one box. Be careful unpacking the box. We recommend keeping the box and original packaging. In the event that the mount needs to be shipped to another location, or returned to Orion for warranty repair, having the proper packaging will help ensure that your mount will survive the journey intact.

Make sure all the parts in the Parts List are present. Be sure to check box carefully, as some parts are small. If anything appears to be missing or broken, immediately call Orion Customer Support (800-676-1343) or email support@telescope.com for assistance.

2. Parts List

1	Tripod
1	Tripod support tray
1	Equatorial mount
1	Latitude adjustment L-bolt
1	Tube ring mounting plate
1	Counterweight shaft
1	Large counterweight
1	Small counterweight
2	Slow-motion control knobs
1	Polar axis finder scope cover

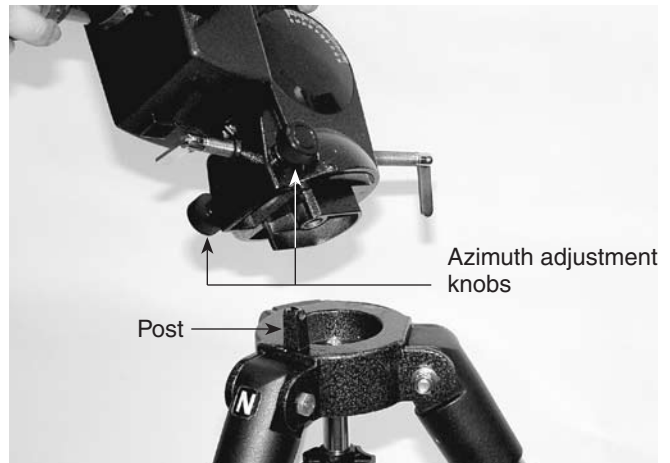

Figure 2. Orient the equatorial mount so that the post on the tripod head lines up with the azimuth adjustment knobs on the equatorial mount.

3. Assembly

1. Stand the tripod upright and spread the legs out as far as they will go. Keep the tripod legs at their shortest (fully retracted) length, for now; you can extend them to a more desirable length later, after the scope is fully assembled.
2. Place the base of the equatorial mount onto the tripod head. Orient the equatorial mount so that the post on the tripod head lines up with the azimuth adjustment knobs on the equatorial mount (Figure 2). You may need to loosen the azimuth adjustment knobs on the equatorial mount in order to fit the mount onto the tripod head.
3. Thread the central support shaft into the equatorial mount until tight. This will secure the equatorial mount to the tripod head.
4. Thread the latitude adjustment L-bolt into the rear of the equatorial mount as show in Figure 1
5. Remove the knob and washer from the bottom of the center support shaft. Slide the tripod support tray up the bottom of the central support shaft until the three tray arms are touching the legs of the tripod. The flat side of the accessory tray should be facing up. Make sure the “V” of each tray arm is against a tripod leg. Place the knob washer on the center support shaft against the tray, and follow

it by threading the securing knob all the way up the center support shaft until it is tight against the tray. The tripod support tray provides additional stability for the tripod, and holds up to five 1.25" eyepieces and two 2" eyepieces.

6. Thread the counterweight shaft into the equatorial mount at the base of the declination axis until tight. Make sure the casting at the top is threaded clockwise as far as it will go before attaching the shaft. Then turn the casting counter-clockwise one the shaft is installed until the top of the casting is flush with the mount.
7. Remove the knurled "toe saver" retaining screw on the bottom of the counterweight shaft and slide both counterweights onto the shaft. Make sure the counterweight lock knobs are adequately loosened to allow the counterweight shaft to pass through the hole. Position the counterweights about halfway up the shaft and tighten the lock knobs. Replace the toe saver at the end of the bar. The toe saver prevents the counterweights from falling on your foot if the lock knobs happen to come loose.
8. Attach the slow-motion control knobs to the right ascension and declination gear shafts of the equatorial mount by sliding them onto the shafts. Line up the flat end of the gear shaft with the interior of the knob. The knobs can be attached to either end of the shafts, whichever is more convenient for you.

Your SkyView Pro EQ mount is now fully assembled and should resemble Figure 1.

4. Attaching a Telescope

The SkyView Pro equatorial mount is designed to hold telescope tubes weighing up to approximately 20 lbs. For heavier telescopes, the mount may not provide sufficient stability for steady imaging. Any type of telescope can be mounted on the SkyView Pro, including refractors, Newtonian reflectors, and catadioptrics, provided a set of tube rings is available to couple the tube to the mount. Orion sells a variety of telescope tube rings. Please visit our website at telescope.com for details.

1. Attach the tube mounting rings to the tube mounting plate using the attachment screws that came with tube rings. The screws should go through the holes on the outer ends of the mounting plate and rethread into the tube rings. Note that the side of the mounting plate with the central "groove" will be facing up.
2. Loosen the black mounting plate securing knob as well as the metal safety screw on the top of the equatorial mount. Place the mounting plate, with the tube rings attached, in the dovetail slot on top of the equatorial mount. Position the mounting plate so that it is centered on the dovetail slot. Re-tighten the mounting plate securing knob until the mounting plate is secure. Then, tighten the safety screw. The safety screw will ensure that the mounting plate (and telescope tube) will not fall off the EQ mount if the mounting plate securing knob should come loose.

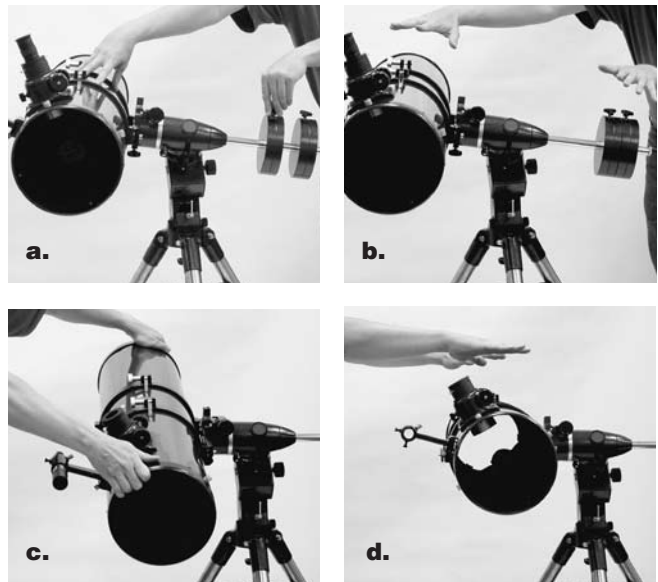

Figure 3. Proper operation of the equatorial mount requires that the telescope tube be balanced on both the R.A. and Dec. axes. (a) With the R.A. lock lever released, slide the counterweights along the counterweight shaft until it just counterbalances the tube. (b) When you let go with both hands, the tube should not drift up or down. (c) With the Dec. lock knob released, loosen the tube ring lock clamps a few turns and slide the telescope forward or back in the tube rings. (d) When the tube is balanced about the Dec. axis, it will not move when you let go.

3. Open the tube rings and lay the telescope optical tube in the rings at about the midpoint of the tube's length. Rotate the tube so that the focuser is at a convenient height for viewing. Close the tube rings and tighten them.

5. Balancing a Telescope

To ensure smooth movement of the telescope on both axes of the equatorial mount, it is imperative that the optical tube is properly balanced. We will first balance the telescope with respect to the right ascension axis, then the declination axis.

1. Keeping one hand on the telescope optical tube, loosen the R.A. lock lever. Make sure the Dec. lock lever is locked, for now. The telescope should now be able to rotate freely about the right ascension axis. Rotate it until the counterweight shaft is parallel to the ground (i.e., horizontal).
2. Now loosen both counterweight lock knobs and slide the weights along the shaft until they exactly counterbalance the telescope (Figure 3a). That's the point at which the shaft remains horizontal even when you let go with both hands (Figure 3b). If the telescope refuses to balance, then you have either too much or too little counterweight. Remove a counterweight if it is too much, or add optional counterweights if it is too little.
3. Retighten the counterweight lock knobs. The telescope is now balanced on the right ascension axis.

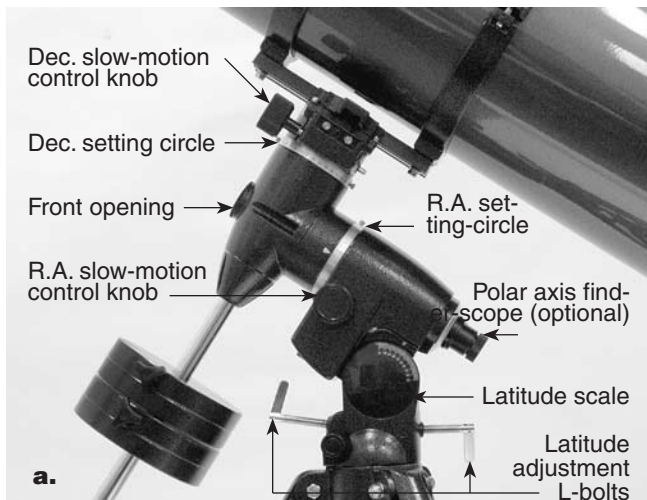

Figure 4. The SkyView Pro Equatorial Mount, shown from both sides.

4. To balance the telescope on the declination axis, first tighten the R.A. lock lever, with the counterweight shaft still in the horizontal position.
5. With one hand on the telescope optical tube, loosen the Dec. lock lever. The telescope should now be able to rotate freely about the Dec. axis. Loosen the tube ring clamps a few turns, until you can slide the telescope tube forward and back inside the rings. (this can be aided by using a slight twisting motion on the optical tube while you push or pull on it). (Figure 3c).
6. Position the telescope in the tube rings so it remains horizontal when you carefully let go with both hands. This is the balance point for the optical tube with respect to the Dec. axis (Figure 3d).
7. Retighten the knurled ring clamps.

The telescope is now balanced on both axes. When you loosen the lock lever on one or both axes and manually point the telescope, it should move without resistance and should not drift from where you point it.

6. Setting Up and Using the Equatorial Mount

When you look at the night sky, you no doubt have noticed that the stars appear to move slowly from east to west over time. That apparent motion is caused by the Earth's rotation (from west to east). An equatorial mount (Figure 4) is designed to compensate for that motion, allowing you to easily "track" the movement of astronomical objects, thereby keeping them from drifting out of your telescope's field of view while you're observing.

This is accomplished by slowly rotating the telescope on its right ascension (R.A.) axis, using only the R.A. slow-motion knob. But first the R.A. axis of the mount must be aligned with the Earth's rotational (polar) axis—a process called polar alignment.

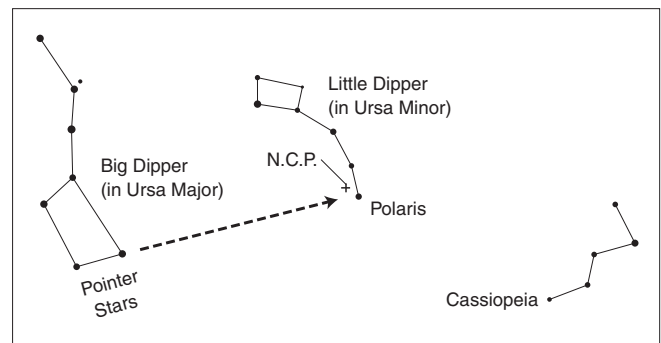

Figure 5. To find Polaris in the night sky, look north and find the Big Dipper. Extend an imaginary line from the two "Pointer Stars" in the bowl of the Big Dipper. Go about five times the distance between those stars and you'll reach Polaris, which lies within 1° of the north celestial pole (NCP).

Polar Alignment

For Northern Hemisphere observers, approximate polar alignment is achieved by pointing the mount's right ascension axis at the North Star, or Polaris. It lies within 1° of the north celestial pole (NCP), which is an extension of the Earth's rotational axis out into space. Stars in the Northern Hemisphere appear to revolve around the NCP.

To find Polaris in the sky, look north and locate the pattern of the Big Dipper (Figure 5). The two stars at the end of the "bowl" of the Big Dipper point right to Polaris.

Observers in the Southern Hemisphere aren't so fortunate to have a bright star so near the south celestial pole (SCP). The star Sigma Octantis lies about 1° from the SCP, but it is barely visible with the naked eye (magnitude 5.5).

For general visual observation, an approximate polar alignment is sufficient.

1. Level the equatorial mount by adjusting the length of the three tripod legs.

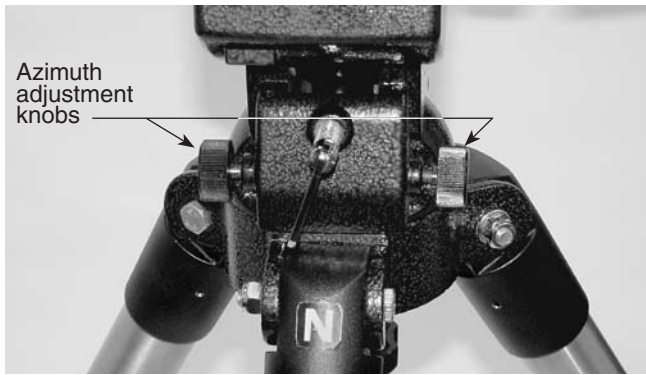

Figure 6. For polar alignment, position the tripod so that the "N" label at the base of the mount faces north. The azimuth fine adjustment knobs above it are used to make small adjustments to the mount's azimuth position. Be certain to loosen the tripod attachment knob on the central support shaft before adjusting these knobs.

2. There are two latitude adjusting L-bolts (see Figure 4); loosen one while tightening the other. By doing this you will adjust the latitude of the mount. Continue adjusting the mount until the pointer on the latitude scale is set at the latitude of your observing site. If you don't know your latitude, consult a geographical atlas to find it. For example, if your latitude is 35° North, set the pointer to 35. The latitude setting should not have to be adjusted again unless you move to a different viewing location some distance away.
3. Loosen the Dec. lock lever and rotate the telescope's optical tube until it is parallel with the right ascension axis, as it is in Figure 4.
4. Move the tripod so the telescope tube and right ascension axis point roughly at Polaris. If you cannot see Polaris directly from your observing site, consult a compass and rotate the tripod so the telescope points north. There is a label bearing a large "N" at the base of the equatorial mount (Figure 6). It should be facing north.

The equatorial mount is now polar aligned for casual observing. More precise polar alignment is recommended for astrophotography. For this we recommend using the optional polar axis finder scope.

From this point on in your observing session, you should not make any further adjustments to the latitude of the mount, nor should you move the tripod. Doing so will undo the polar alignment. The telescope should be moved only about its R.A. and Dec. axes.

Polar Alignment Using an Optional Polar Axis Finder Scope

The SkyView Pro EQ mount can be equipped with an optional polar axis finder scope (Figure 7a) housed inside the right ascension axis of the mount. When properly aligned and used, it makes accurate polar alignment quick and easy to do.

To install the polar axis finder scope, remove the cap at the base of the mount's right ascension axis (Figure 7b) and

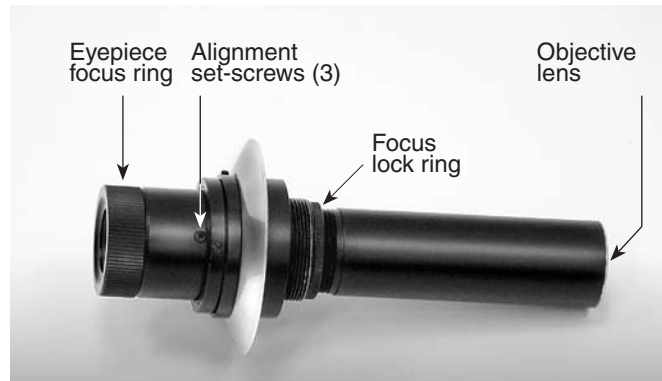

Figure 7a. The optional polar axis finder scope.



Figure 7b. Installing the optional polar axis finder scope.

thread the polar axis finder scope into the equatorial mount until tight.

Alignment of the Polar Axis Finder Scope

1. Loosen the Dec. lock lever and rotate the optical tube on the declination axis so that the tube is at a 90° to the right ascension axis (Figure 8). Tighten the Dec. lock lever.
2. Look through the polar finder at a distant object (during the day) and center it in the crosshairs. You may need to adjust the latitude adjustment L-bolts and the tripod position to do this.
3. Rotate the mount 180° about the R.A. axis. Again, it may be convenient to remove the counterweights and optical tube first.
4. Look through the polar finder again. Is the object being viewed still centered on the crosshairs? If it is, then no further adjustment is necessary. If not, then look through the polar finder while rotating the mount about the R.A. axis. You will notice that the object you have previously centered moves in a circular path. Use the three alignment setscrews on the polar axis finder to redirect the crosshairs of the polar finder to the apparent center of this circular path. Repeat this procedure until the position that the crosshairs point to does not rotate off-center when the mount is rotated in R.A. Once this is accomplished, retighten the thumbscrews.



Figure 8. The optical tube must be at a 90° angle to the right ascension axis in order to view through the polar axis finder

The polar axis finder scope is now ready to be used. When not in use, replace the plastic protective cover to prevent the polar finder from getting bumped, which could knock it out of alignment.

Using the Polar Axis Finder Scope

The reticle of the polar axis finder scope for the SkyView Pro has a tiny star map printed on it that makes precise polar alignment quick and easy. To align the mount using the polar axis finder scope, follow these instructions:

1. Approximately polar-align the mount as outlined in the previous procedure.
2. Loosen the Dec. lock lever and rotate the optical tube on the declination axis so that the tube is at a 90° to the right ascension axis (Figure 8). Tighten the Dec. lock lever.
3. Remove the cap on the front opening of the mount (Figure 4). Focus the polar finder by rotating its eyepiece. Now, sight Polaris in the polar axis finder scope. If you have followed the approximate polar alignment procedure accurately, Polaris will probably be within the field of view. If not, move the tripod left-to-right, and adjust the latitude up-and down until Polaris is somewhere within the field of view of the polar axis finder scope.
4. Shine a red flashlight down the front end of the polar finder to illuminate the reticle within the field of view. Make sure the flashlight shines in at an angle, so as not to block the polar finder's field of view. It may be helpful to have a friend hold the flashlight while you look through the polar finder. Note the constellation Cassiopeia and the Big Dipper in the reticle. They do not appear in scale, but they indicate

the general positions of Cassiopeia and the Big Dipper relative to the north celestial pole (which is indicated by the cross at the center of the reticle). Rotate the reticle so the constellations depicted match their current orientation in they sky when viewed with the naked eye. To do this, release the R.A. lock lever and rotate the main telescope around the R.A. axis until the reticle is oriented with sky. For larger optical tubes, you may need to remove the tube from the mount to prevent it from bumping into the mount. Once the reticle is correctly oriented, use the right ascension lock lever to secure the mount's position.

5. Now use the azimuth adjustment knobs (Figure 2) and the latitude adjustment L-bolts (Figure 4) on the mount to position the star Polaris inside the tiny circle marked "Polaris" on the finder's reticle. You must first loosen the knob underneath the equatorial mount on the center support shaft to use the azimuth adjustment knobs. Once Polaris is properly positioned within the reticle, you are precisely polar aligned.

If you do not have a clear view of Polaris from your observing site, you will not be able to use the polar-axis finder to precisely polar align the telescope.

Note: From this point on in your observing session, you should not make any further adjustments in the azimuth or the latitude of the mount, nor should you move the tripod. Doing so will undo the polar alignment. The telescope should be moved only about its right ascension and declination axes.

Use of the Right Ascension and Declination Slow-Motion Control Knobs

The right ascension (R.A.) and declination (Dec.) slow-motion control knobs allow fine adjustment of the telescope's position to center objects within the field of view. Before you can use the knobs, you must manually "slew" the mount to point the telescope in the vicinity of the desired target. Do this by loosening the R.A. and Dec. lock levers and moving the telescope about the mount's right ascension and declination axes. Once the telescope is pointed close to the object to be viewed, retighten both lock levers.

Note: If you have an optional motor drive attached you will need to loosen the manual clutch on the R.A. (and Dec. for dual-axis drives) gear shaft before using the slow-motion control knob.

The object should now be visible somewhere in the telescope's finder scope. If it isn't, use the slow-motion knobs to scan the surrounding area of sky. When the object is visible in the finder scope, use the slow-motion knobs to center it. Now, look in the telescope's eyepiece. If the finder scope is properly aligned, the object should be visible somewhere in the field of view. Once the object is visible in the eyepiece, use the slow-motion knobs to center it in the field of view.

Tracking Celestial Objects

When you observe a celestial object through the telescope, you'll see it drift slowly across the field of view. To keep it in

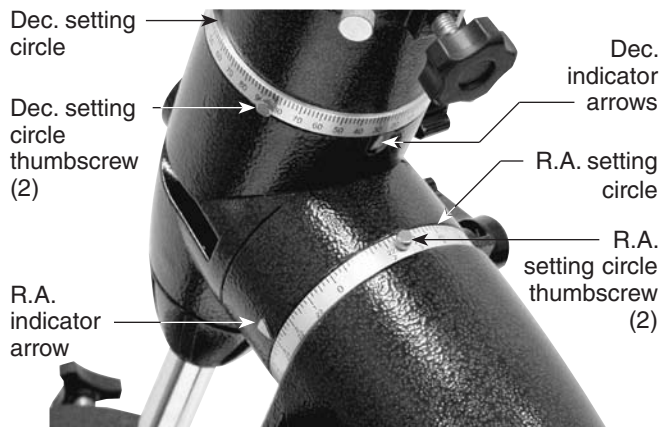

Figure 9. The R.A. and Dec. setting circles.

the field, if your equatorial mount is polar aligned, just turn the R.A. slow-motion control knob clockwise. The Dec. slow-motion control knob is not needed for tracking. Objects will appear to move faster at higher magnifications, because the field of view is narrower.

Optional Motor Drives for Automatic Tracking

An optional DC motor drive can be mounted on the R.A. axis of the equatorial mount to provide hands-free tracking. Objects will then remain stationary in the field of view without any manual adjustment of the right ascension slow-motion control knob.

Understanding the Setting Circles

The setting circles on an equatorial mount enable you to locate celestial objects by their “celestial coordinates”. Every object resides in a specific location on the “celestial sphere”. That location is denoted by two numbers: its right ascension (R.A.) and declination (Dec.). In the same way, every location on Earth can be described by its longitude and latitude. Right ascension is similar to longitude on Earth, and declination is similar to latitude. The R.A. and Dec. values for celestial objects can be found in any star atlas or star catalog.

The R.A. setting circle is scaled in hours, from 1 through 24, with small marks in between representing 10-minute increments (there are 60 minutes in 1 hour of right ascension). The lower set of numbers apply to viewing in the Northern Hemisphere, while the numbers above them apply to viewing in the Southern Hemisphere. The location of the right ascension coordinate indicator arrow is shown in Figure 9.

The Dec. setting circle is scaled in degrees, with each mark representing 2° increments. Values of declination coordinates range from +90° to -90°. The 0° mark indicates the celestial equator. When the telescope is pointed north of the celestial equator, values of the declination setting circle are positive; when the telescope is pointed south of the celestial equator, values of the declination setting circle are negative.

So, the coordinates for the Orion Nebula listed in a star atlas will look like this:

R.A. 5h 35.4m Dec. -5° 27'

That's 5 hours and 35.4 minutes in right ascension, and -5 degrees and 27 arc-minutes in declination (there are 60 arc-minutes in 1 degree of declination).

Before you can use the setting circles to locate objects, the mount must be accurately polar aligned, and the setting circles must be calibrated.

Calibrating the Declination Setting Circle

1. Loosen the Dec. lock lever and position the telescope as accurately as possible in declination so it is parallel to the R.A. axis, as shown in Figure 4. Re-tighten the lock lever.
2. Loosen one of the thumbscrews on the Dec. setting circle, this will allow the setting circle to rotate freely. Rotate the Dec. setting circle until the pointer reads exactly 90°. Re-tighten the setting circle thumbscrew.

Calibrating the Right Ascension Setting Circle

1. Identify a bright star in the sky near the celestial equator (declination = 0°) and look up its coordinates in a star atlas.
2. Loosen the R.A. and Dec. lock levers on the equatorial mount, so the telescope optical tube can move freely.
3. Point the telescope at the bright star whose coordinates you know. Lock the R.A. and Dec. lock levers.
4. Loosen one of the R.A. setting circle thumbscrews (see Figure 9; this will allow the setting circle to rotate freely. Rotate the setting circle until the R.A. pointer arrow indicates the R.A. coordinate listed in the star atlas for the object. Re-tighten the setting circle thumbscrew.

Finding Objects With the Setting Circles

Now that both setting circles are calibrated, look up in a star atlas the coordinates of an object you wish to view.

1. Loosen the Dec. lock lever and rotate the telescope until the declination value from the star atlas matches the reading on the Dec. setting circle. Remember that values of the Dec. setting circle are positive when the telescope is pointing north of the celestial equator (Dec. = 0°), and negative when the telescope is pointing south of the celestial equator. Retighten the lock lever.
2. Loosen the R.A. lock lever and rotate the telescope until the right ascension value from the star atlas matches the reading on the R.A. setting circle. Remember to use the upper set of numbers on the R.A. setting circle. Retighten the lock lever.

Most setting circles are not accurate enough to put an object dead-center in the telescope's eyepiece, but they should place the object somewhere within the field of view of the finder scope, assuming the equatorial mount is accurately polar aligned. Use the slow-motion controls to center the object in the finder scope, and it should appear in the telescope's field of view.

The setting circles must be re-calibrated every time you wish to locate a new object. Do so by calibrating the setting circles for the centered object before moving on to the next one.

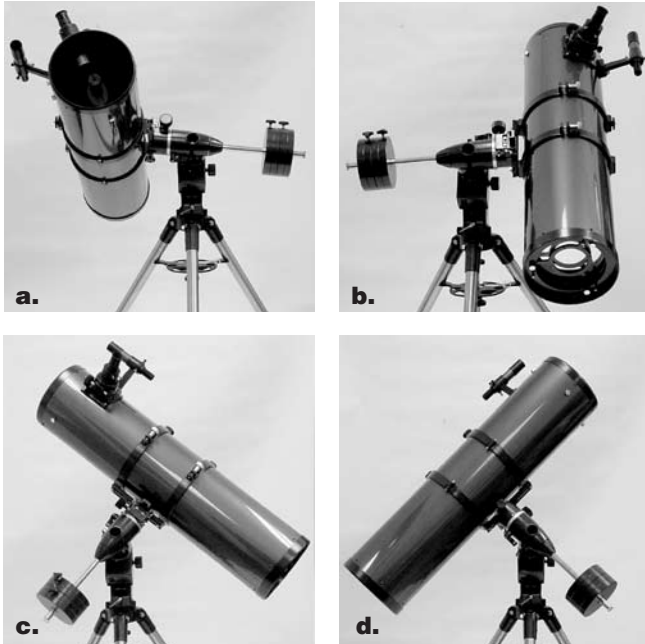

Figure 10. This illustration show the telescope pointed in the the four cardinal directions (a) north, (b) south, (c) east, (d) west. Note that the tripod and mount have ot been moved; only the telescope tube has been moved on the R.A. and Dec. axes.

Confused About Pointing the Telescope?

Beginners occasionally experience some confusion about how to point the telescope overhead or in other directions. In Figure 1 the telescope is pointed north as it would be during polar alignment. The counterweight shaft is oriented downward. But it will not look like that when the telescope is pointed in other directions. Let's say you want to view an object that is directly overhead, at the zenith. How do you do it?

DO NOT make any adjustment to the latitude adjustment L-bolts. That will spoil the mount's polar alignment. Remember, once the mount is polar aligned, the telescope should be moved only on the R.A. and Dec. axes. To point the scope overhead, first loosen the R.A. lock lever and rotate the telescope on the right ascension axis until the counterweight shaft is horizontal (parallel to the ground). Then loosen the Dec. lock lever and rotate the telescope until it is pointing

straight overhead. The counterweight shaft is still horizontal. Then retighten both lock levers.

What if you need to aim the telescope directly north, but at an object that is nearer to the horizon than Polaris? You can't do it with the counterweights down as pictured in Figure 1. Again, you have to rotate the scope in right ascension so that the counterweight shaft is positioned horizontally. Then rotate the scope in declination so it points to where you want it near the horizon.

To point the telescope directly south, the counterweight shaft should again be horizontal. Then you simply rotate the scope on the declination axis until it points in the south direction.

To point the telescope to the east or west, or in other directions, you rotate the telescope on its right ascension and declination axes. Depending on the altitude of the object you want to observe, the counterweight shaft will be oriented somewhere between vertical and horizontal.

Figure 10 illustrates how the telescope will look when pointed at the four cardinal directions: north, south, east and west.

The key things to remember when pointing the telescope are that a) you only move it in right ascension and declination, not in azimuth or latitude (altitude), and b) the counterweight and shaft will not always appear as it does in Figure 1. In fact it almost never will!

7. Specifications

Mount: German equatorial

Tripod: Aluminum

Weight: 29 lbs. 8 oz.

Counterweight: Large, 7 lbs. 9 oz. ; Small 4 lbs.

Slow-motion adjustment: R.A. and Dec. axes

Setting circles: R.A. scaled in 10 min. increments, Dec. scaled in 2° increments for N or S hemisphere

Polar axis latitude adjustment: 5° to 75°

Polar axis finder scope: Optional

Motor drives: Optional

One-Year Limited Warranty

This Orion SkyView Pro EQ Mount is warranted against defects in materials or workmanship for a period of one year from the date of purchase. This warranty is for the benefit of the original retail purchaser only. During this warranty period Orion Telescopes & Binoculars will repair or replace, at Orion's option, any warranted instrument that proves to be defective, provided it is returned postage paid to: Orion Warranty Repair, 89 Hangar Way, Watsonville, CA 95076. If the product is not registered, proof of purchase (such as a copy of the original invoice) is required.

This warranty does not apply if, in Orion's judgment, the instrument has been abused, mishandled, or modified, nor does it apply to normal wear and tear. This warranty gives you specific legal rights, and you may also have other rights, which vary from state to state. For further warranty service information, contact: Customer Service Department, Orion Telescopes & Binoculars, 89 Hangar Way, Watsonville, CA 95076; (800)-676-1343.

Orion Telescopes & Binoculars

89 Hangar Way, Watsonville, CA 95076

Customer Support Help Line (800)-676-1343 • Day or Evening